

# 9984/9985 SERIES

## Board to Board Connectors



This is a 0.5mm pitch, Board to Board, SMT type connector with a two-point contact mechanism reliability. In case of Iriso's Tandem Contact Connector, the first contact would remove foreign materials (contamination) for better contact reliability. Even if the first contact were on foreign material, the second contact would still be securely touching the contact surface (and vice versa).

### Features

- Dual point of contact mechanism (Tandem™ Contact)
- Dual surface contact design to realize excellent contact reliability
- With cap to prevent contamination of the area
- Absorbs fitting gaps of +/-0.5mm in the X, Y, and Z directions.
- Straight and Right angle types are available
- Multiple stacking height variations (Please ask the latest variations)
- Automatic mounting (embossed package)

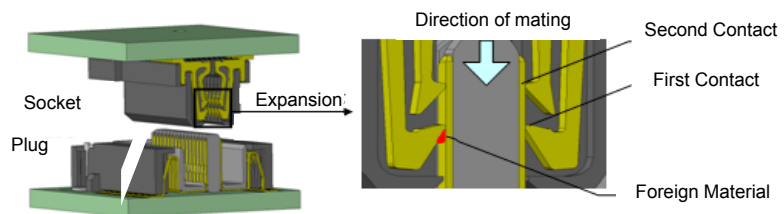

### Specifications

	9984S/B	9985S
①Application/Parts No.	Straight TYPE IMSA-9984□-**Y□□□	Right Angle TYPE IMSA-9985S-**Y□□□
②Pitch	0.5mm	0.5mm
③No. of contacts	40,(50),60,80,100,120,140P	40,60,80,100,120,140P
④Stacking Height	8,10,12,14mm±0.5mm	—
⑤Rated Voltage	50V(AC,DC)	50V(AC,DC)
⑥Rated Current	0.4A	0.4A
⑦Resistance to Voltage	AC250V (1min)	AC250V (1min)
⑧Insulation Resistance	500m or more(DC250V)	500m or more(DC250V)
⑨Contact Resistance	100mΩ MAX	100mΩ MAX
⑩Working Temperature Range	-40~+105°C	-40~+105°C
⑪Finish	Over Ni Plate, Au Plate	Over Ni Plate, Au Plate

# 9984 SERIES

## IMSA-9984S-\*\*B□-GFN1

EMBOSSED PACKAGE; IMSA-9984S-\*\*Y911

## SERIES 9984 SOCKET

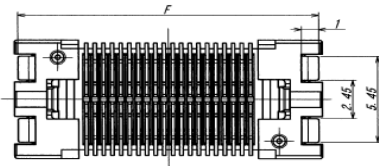
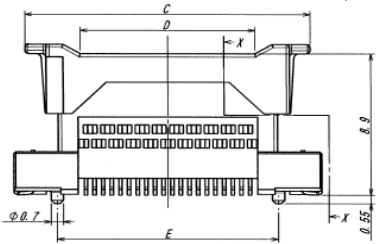
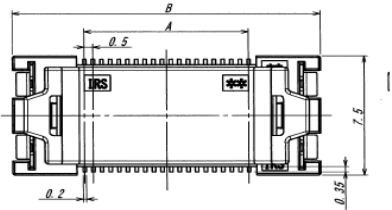

□=A: Without boss, □=B: With boss  
Y910=Without boss, Y911=With boss

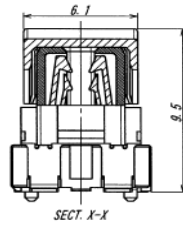
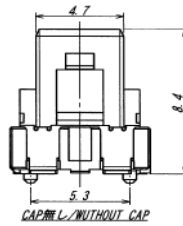

極数 CKT	製品番号 PRODUCTS No.	A	B	C	D	E	F
40	9984S-40BB-GFN1	9.5	17.8	16.5	10.1	12.8	17.4
60	9984S-60BB-GFN1	14.5	22.8	21.5	15.1	17.8	22.4
80	9984S-80BB-GFN1	19.5	27.8	26.5	20.1	22.8	27.4
100	9984S-100BB-GFN1	24.5	32.8	31.5	25.1	27.8	32.4
120	9984S-120BB-GFN1	29.5	37.8	36.5	30.1	32.8	37.4
140	9984S-140BB-GFN1	34.5	42.8	41.5	35.1	37.8	42.4

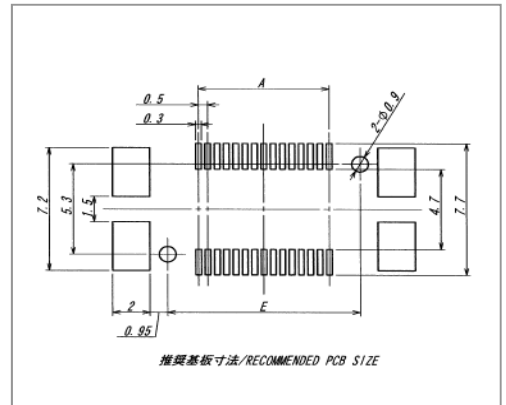

## IMSA-9984S-\*\*C□-GFN1

EMBOSSED PACKAGE; IMSA-9984S-\*\*Y921

## SERIES 9984 SOCKET

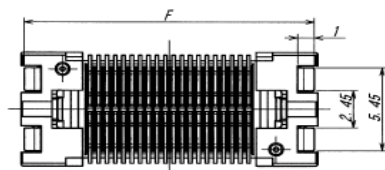
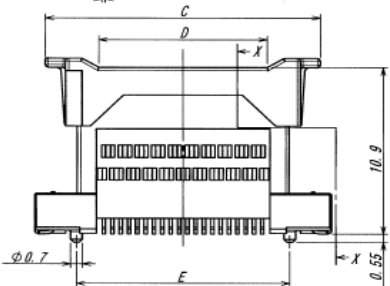
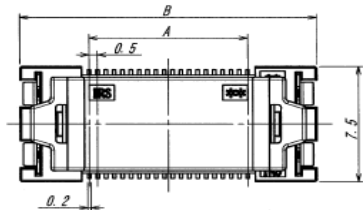

□=A: Without boss, □=B: With boss  
Y920=Without boss, Y921=With boss

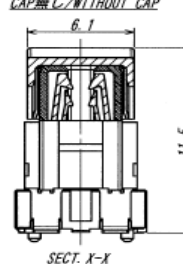
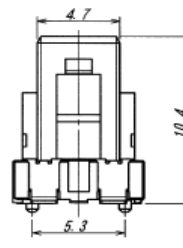

極数 CKT	製品番号 PRODUCTS No.	A	B	C	D	E	F
40	9984S-40CB-GFN1	9.5	17.8	16.5	10.1	12.8	17.4
50	9984S-50CB-GFN1	12.0	20.3	19.0	12.6	15.3	19.9
60	9984S-60CB-GFN1	14.5	22.8	21.5	15.1	17.8	22.4
80	9984S-80CB-GFN1	19.5	27.8	26.5	20.1	22.8	27.4
100	9984S-100CB-GFN1	24.5	32.8	31.5	25.1	27.8	32.4
120	9984S-120CB-GFN1	29.5	37.8	36.5	30.1	32.8	37.4
140	9984S-140CB-GFN1	34.5	42.8	41.5	35.1	37.8	42.4

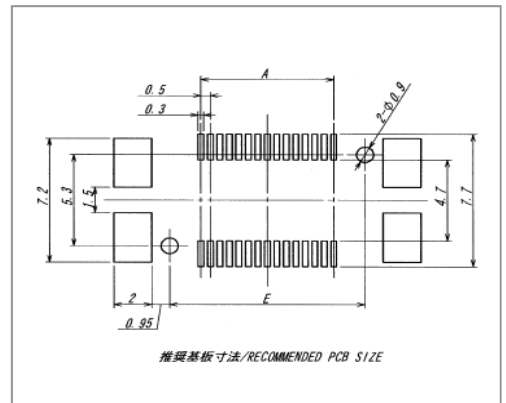

# 9984 SERIES

## IMSA-9984B-\*\*□-GFN1

EMBOSSED PACKAGE; IMSA-9984B-\*\*Y900

## SERIES 9984 PLUG

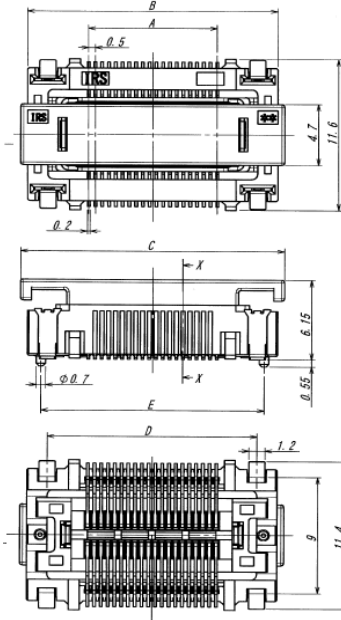

極数 CKT	製品番号 PRODUCTS No.	A	B	C	D	E
40	9984B-40B-GFN1	9.5	18.5	19.5	15.5	16.5
50	9984B-50B-GFN1	12.0	21.0	22.0	18.0	19.0
60	9984B-60B-GFN1	14.5	23.5	24.5	20.5	21.5
80	9984B-80B-GFN1	19.5	28.5	29.5	25.5	26.5
100	9984B-100B-GFN1	24.5	33.5	34.5	30.5	31.5
120	9984B-120B-GFN1	29.5	38.5	39.5	35.5	36.5
140	9984B-140B-GFN1	34.5	43.5	44.5	40.5	41.5

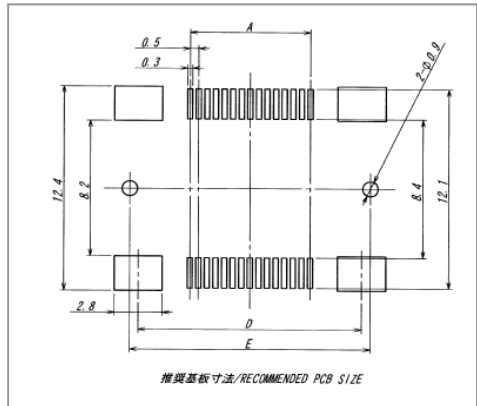
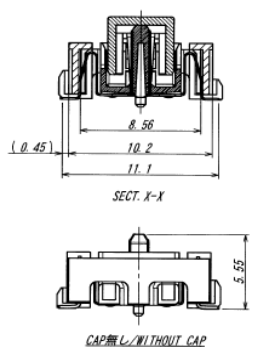

□=A: Without boss, □=B: With boss  
Y900=Without boss, Y901=With boss

## IMSA-9984S-\*\*A□-GFN1

EMBOSSED PACKAGE; IMSA-9984S-\*\*Y901

## SERIES 9984 SOCKET

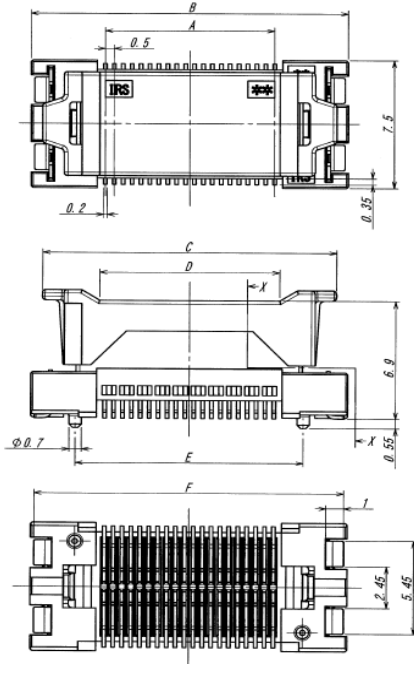

極数 CKT	製品番号 PRODUCTS No.	A	B	C	D	E	F
40	9984S-40AB-GFN1	9.5	17.8	16.5	10.1	12.8	17.4
60	9984S-60AB-GFN1	14.5	22.8	21.5	15.1	17.8	22.4
80	9984S-80AB-GFN1	19.5	27.8	26.5	20.1	22.8	27.4
100	9984S-100AB-GFN1	24.5	32.8	31.5	25.1	27.8	32.4
120	9984S-120AB-GFN1	29.5	37.8	36.5	30.1	32.8	37.4
140	9984S-140AB-GFN1	34.5	42.8	41.5	35.1	37.8	42.4

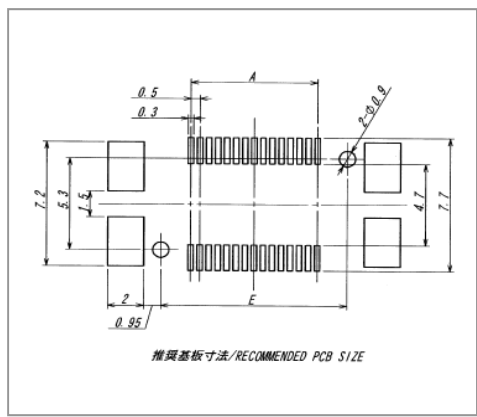
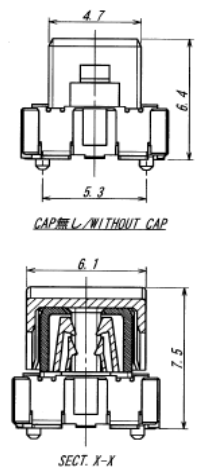

□=A: Without boss, □=B: With boss  
Y900=Without boss, Y901=With boss

# 9984/9985 SERIES

## IMSA-9984S-\*\*D□-GFN1

## SERIES 9984 SOCKET

EMBOSSED PACKAGE; IMSA-9984B-\*\*Y931

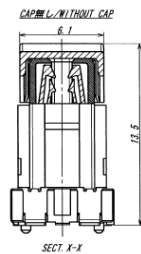
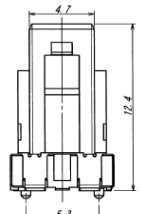
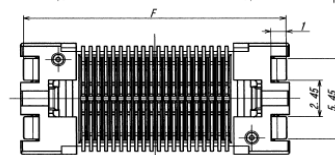
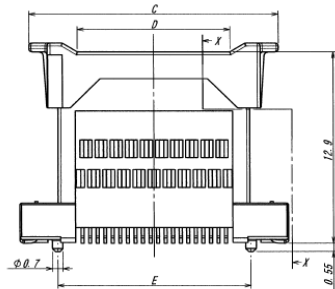
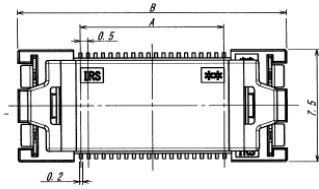

極数 CKT	製品番号 PRODUCTS No.	A	B	C	D	E	F
40	9984S-40DB-GFN1	9.5	17.8	16.5	10.1	12.8	17.4
60	9984S-60DB-GFN1	14.5	22.8	21.5	15.1	17.8	22.4
80	9984S-80DB-GFN1	19.5	27.8	26.5	20.1	22.8	27.4
100	9984S-100DB-GFN1	24.5	32.8	31.5	25.1	27.8	32.4
120	9984S-120DB-GFN1	29.5	37.8	36.5	30.1	32.8	37.4
140	9984S-140DB-GFN1	34.5	42.8	41.5	35.1	37.8	42.4

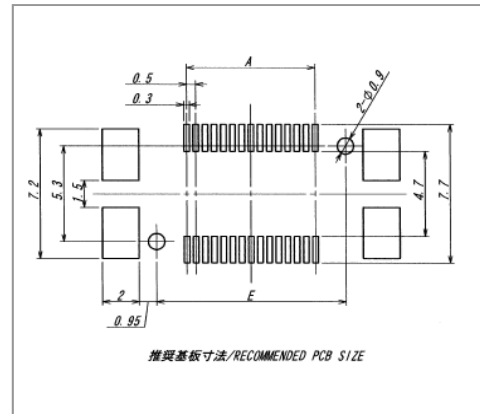

□=A: Without boss, □=B: With boss  
Y930=Without boss, Y931=With boss

## IMSA-9985S-\*\*B-GFN1

## SERIES 9985 SOCKET

EMBOSSED PACKAGE; IMSA-9985S-\*\*Y900

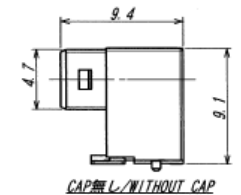
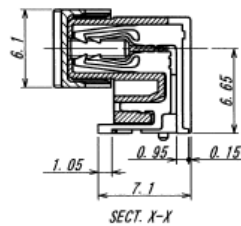
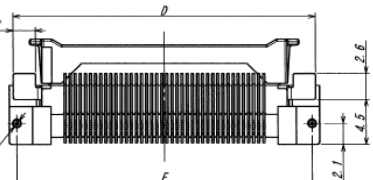
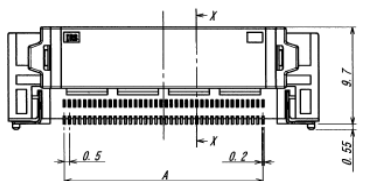
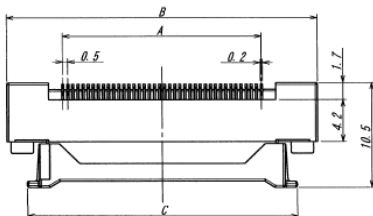

極数 CKT	製品番号 PRODUCTS No.	A	B	C	D	E	F
40	9985S-40B-GFN1	9.5	20.5	16.5	19.7	16.85	19.0
60	9985S-60B-GFN1	14.5	25.5	21.5	24.7	21.85	24.0
80	9985S-80B-GFN1	19.5	30.5	26.5	29.7	26.85	29.0
100	9985S-100B-GFN1	24.5	35.5	31.5	34.7	31.85	34.0
120	9985S-120B-GFN1	29.5	40.5	36.5	39.7	36.85	39.0
140	9985S-140B-GFN1	34.5	45.5	41.5	44.7	41.85	44.0

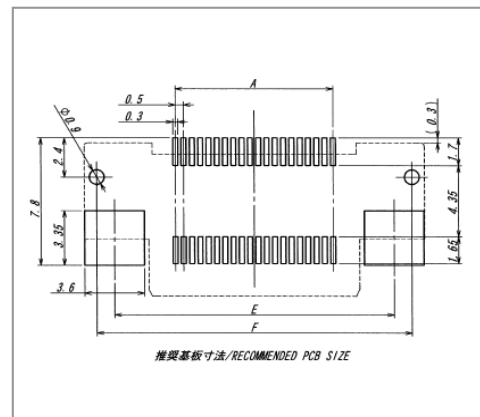

□=A: Without boss, □=B: With boss  
Y900=Without boss, Y901=With boss

**IRISO U.S.A., INC.**

34405 West Twelve Mile Road, Suite 237 Farmington Hills, MI 48331, U.S.A.  
TEL: 248-324-9780 FAX: 248-324-9783  
<http://www.iriso.co.jp/>

\*Specification is subject to change without prior notice for improving performance of the product and so on.  
\*Dimension and specification described herein are limited to major items. When applying the products, please confirm details on drawing and specification sheets which will be provided upon request.